

LH28F020SU-N

2M (256K × 8) Flash Memory

FEATURES

- 256K × 8 Bit Configuration
- 5 V Write/Erase Operation (5 V V_{PP})
 - No Requirement for DC/DC Converter to Write Erase
- 80 ns Maximum Access Time
- 16 Independently Lockable Blocks (16K)
- 100,000 Erase Cycles per Block
- Automated Byte Write/Block Erase
 - Command User Interface
 - Status Register
- System Performance Enhancement
 - Erase Suspend for Read
 - Two-Byte Write
 - Full Chip Erase
- Data Protection
 - Hardware Erase/Write Lockout during Power Transitions
 - Software Erase/Write Lockout
- Independently Lockable for Write/Erase on Each Block (Lock Block and Protect Set/Reset)
- 5 μ A (TYP.) I_{CC} in CMOS Standby
- State-of-the-Art 0.55 μ m ETOX™ Flash Technology
- Packages
 - 32-Pin, 525 mil. SOP Package
 - 32-Pin, 1.2 mm × 8 mm × 20 mm TSOP (Type I) Package

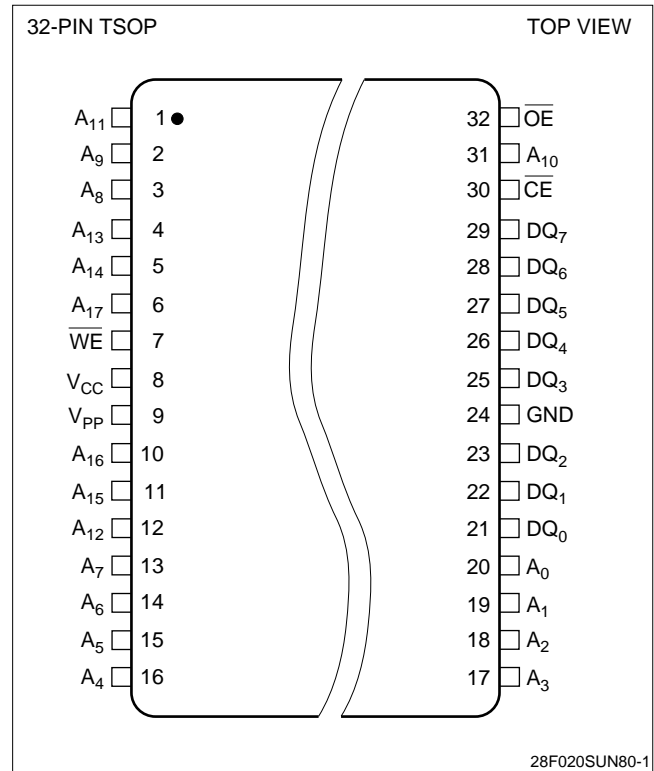

Figure 1. TSOP Configuration

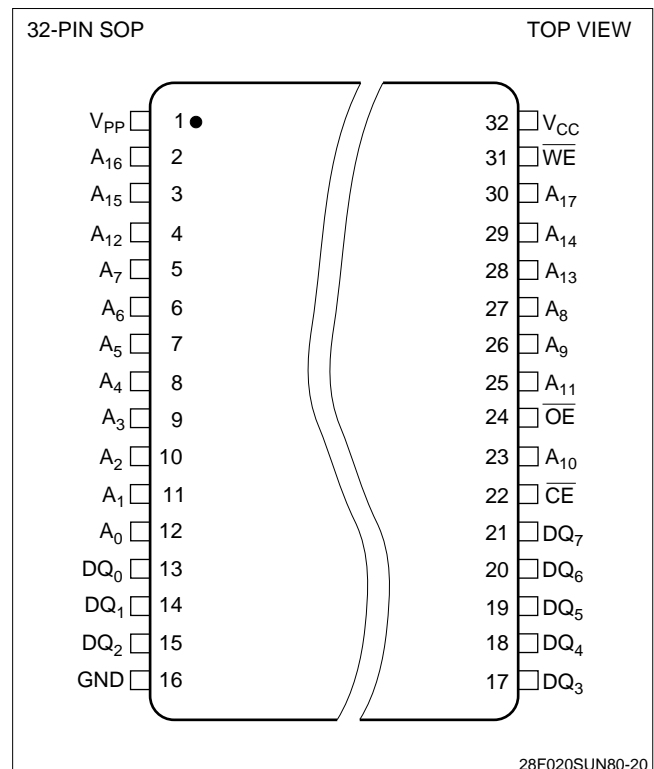
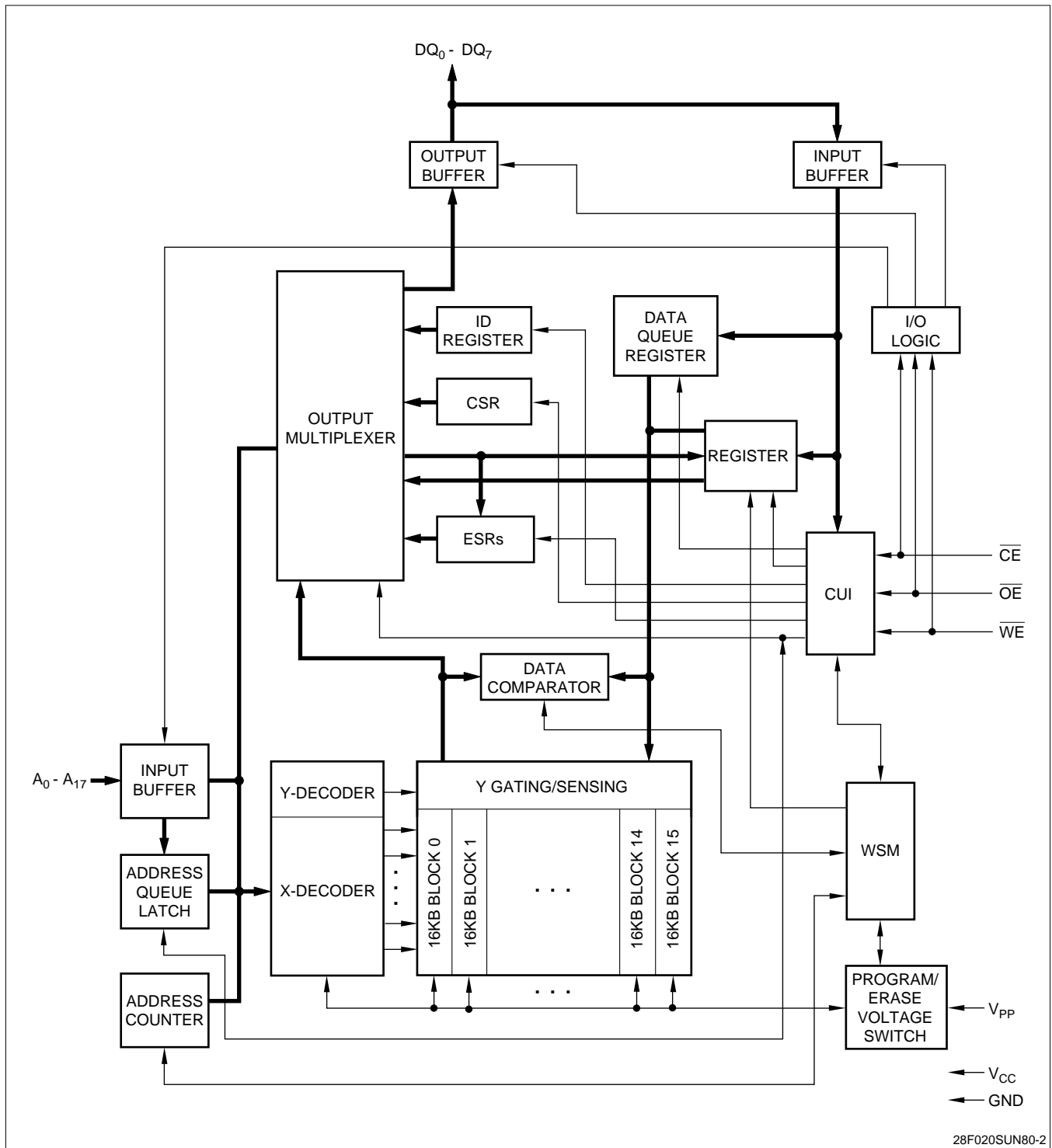

Figure 2. SOP Configuration



28F020SUN80-2

Figure 3. LH28F020SU-N Block Diagram

PIN DESCRIPTION

SYMBOL	TYPE	NAME AND FUNCTION
$A_0 - A_{13}$	INPUT	BYTE-SELECT ADDRESSES: Select a byte within one 16K block. These addresses are latched during Data Writes.
$A_{14} - A_{17}$	INPUT	BLOCK-SELECT ADDRESSES: Select 1 of 16 Erase Blocks. These addresses are latched during Data Writes, Erase and Lock-Block operations.
$DQ_0 - DQ_7$	INPUT/OUTPUT	DATA INPUT/OUTPUT: Inputs data and commands during CUI write cycles. Outputs array, buffer, identifier or status data in the appropriate Read mode. Floated when the chip is de-selected or the outputs are disabled.
\overline{CE}	INPUT	CHIP ENABLE INPUTS: Activate the device's control logic, input buffers, decoders and sense amplifiers. \overline{CE} must be low to select the device.
\overline{OE}	INPUT	OUTPUT ENABLE: Gates device data through the output buffers when low. The outputs float to tri-state off when \overline{OE} is high.
\overline{WE}	INPUT	WRITE ENABLE: Controls access to the CUI, Page Buffers, Data Queue Registers and Address Queue Latches. \overline{WE} is active low, and latches both address and data (command or array) on its rising edge.
V_{PP}	SUPPLY	ERASE/WRITE POWER SUPPLY (5.0 V ±0.5 V): For erasing memory array blocks or writing words/bytes/pages into the flash array.
V_{CC}	SUPPLY	DEVICE POWER SUPPLY (5.0 V ±0.5 V): Do not leave any power pins floating.
GND	SUPPLY	GROUND FOR ALL INTERNAL CIRCUITRY: Do not leave any ground pins floating.

INTRODUCTION

Sharp's LH28F020SU-N 2M Flash Memory is a revolutionary architecture which enables the design of truly mobile, high performance, personal computing and communication products. With innovative capabilities, 5.0V single voltage operations and very high read/write performance, the LH28F020SU-N is also the ideal choice for designing embedded mass storage flash memory systems.

The LH28F020SU-N is a very high density, highest performance non-volatile read/write solution for solid-state storage applications. Its independently lockable 16 symmetrical blocked architecture (16K each) extended cycling, low power operation, very fast write and read performance and selective block locking provide a highly flexible memory component suitable for high density memory cards, Resident Flash Arrays and PCMCIA-ATA Flash Drives. The LH28F020SU-N single voltage power supply operation enables the design of memory cards which can be read/written in 5.0 V systems. Its x8 architecture allows the optimization of memory to processor interface. The flexible block locking option enables bundling of executable application software in a Resident Flash Array or memory card. Manufactured on Sharp's 0.55 μm ETOX™ process technology, the LH28F020SU-N is the most cost-effective, high density 5.0 V flash memory.

Description

The LH28F020SU-N is a high performance 2M (2,097,152 bit) block erasable non-volatile random access memory organized as 256K × 8. The LH28F020SU-N includes sixteen 16K (16,384) blocks. A chip memory map is shown in Figure 4.

The implementation of a new architecture, with many enhanced features, will improve the device operating characteristics and results in greater product reliability and ease of use.

Among the significant enhancements of the LH28F020SU-N80:

- 5 V Read, Write/Erase Operation (5 V V_{CC} , 5.0 V V_{PP})
- Lower Power Capability
- Improved Write Performance
- Dedicated Block Write/Erase Protection
- Command-Controlled Memory Protection Set/Reset Capability

The LH28F020SU-N will be available in a 32-pin, 525 mil. SOP package. This form factor and pinout allow for very high board layout densities.

The LH28F020SU-N will be available in a 32-pin, 1.2 mm thick, 8 mm × 20 mm TSOP (Type I) package. This form factor and pinout allow for very high board layout densities.

A Command User Interface (CUI) serves as the system interface between the microprocessor or microcontroller and the internal memory operation.

Internal Algorithm Automation allows Byte Writes and Block Erase operations to be executed using a Two-Write command sequence to the CUI in the same way as the LH28F008SA 8M Flash memory.

A Superset of commands have been added to the basic LH28F008SA command-set to achieve higher write performance and provide additional capabilities. These new commands and features include:

- Software Locking of Memory Blocks
- Memory Protection Set/Reset Capability
- Two-Byte Serial Writes in 8-bit Systems
- Erase All Unlocked Blocks

Writing of memory data is performed typically within 13 μ s. A Block Erase operation erases one of the 16 blocks in typically 0.6 seconds, independent of the other blocks.

LH28F020SU-N allows to erase all unlocked blocks. It is desirable in case you have to implement Erase operation maximum 16 times.

LH28F020SU-N enables two-byte serial Write which is operated by three times command input. This feature can improve system write performance by up to typically 10 μ s per byte.

All operations are started by a sequence of Write commands to the device. Status Register (described in detail later) provide information on the progress of the requested operation.

Same as the LH28F008SA, LH28F020SU-N requires an operation to complete before the next operation can be requested, also it allows to suspend block erase to read data from any other block, and allow to resume erase operation.

The LH28F020SU-N provides user-selectable block locking to protect code or data such as Device Drivers, PCMCIA card information, ROM-Executable OS or Application Code. Each block has an associated non-volatile lock-bit which determines the lock status of the block. In addition, the LH28F020SU-N has a software controlled master Write Protect circuit which prevents any modifications to memory blocks whose lock-bits are set.

When the device power-up, Write Protect Set/Confirm command must be written. Otherwise, all lock bits in the device remain being locked, can't perform the Write to each block and single Block Erase. Write Protect Set/Confirm command must be written to reflect the actual lock status. However, when the device power-on, Erase All Unlocked Blocks can be used. If used, Erase is performed with reflecting actual lock status, and after that Write and Block Erase can be used.

The LH28F020SU-N contains Status Register to accomplish various functions:

- A Compatible Status Register (CSR) which is 100% compatible with the LH28F008SA Flash memory's Status Register. This register, when used alone, provides a straightforward upgrade capability to the LH28F020SU-N from a LH28F008SA based design.

The LH28F020SU-N is specified for a maximum access time of 80 ns (t_{ACC}) at 5 V operation (4.5 to 5.5 V) over the commercial temperature range (0 to +70°C).

The LH28F020SU-N incorporates an Automatic Power Saving (APS) feature which substantially reduces the active current when the device is in static mode of operation (addresses not switching).

In APS mode, the typical I_{CC} current is 2 mA at 5.0V.

A chip reset mode of operation is enabled when \overline{CE} , \overline{WE} and \overline{OE} hold low more than 5 μ s. In this mode, all operations are aborted, WSM is reset and CSR register is cleared. If \overline{CE} and or \overline{WE} and or \overline{OE} and or goes high, chip reset mode will be finished. It needs more than 500 ns from one of the \overline{CE} , \overline{WE} or \overline{OE} goes high until output data are valid.

A CMOS Standby mode of operations is enabled when \overline{CE} transitions high will all input control pins at CMOS levels. In this mode, the device draws an I_{CC} standby current of 10 μ A.

MEMORY MAP

3FFFFH	16KB BLOCK	15
3C000H		
3BFFFH	16KB BLOCK	14
38000H		
37FFFH	16KB BLOCK	13
34000H		
33FFFH	16KB BLOCK	12
30000H		
2FFFFH	16KB BLOCK	11
2C000H		
2BFFFH	16KB BLOCK	10
28000H		
27FFFH	16KB BLOCK	9
24000H		
23FFFH	16KB BLOCK	8
20000H		
1FFFFH	16KB BLOCK	7
1C000H		
1BFFFH	16KB BLOCK	6
18000H		
17FFFH	16KB BLOCK	5
14000H		
13FFFH	16KB BLOCK	4
10000H		
0FFFFH	16KB BLOCK	3
0C000H		
0BFFFH	16KB BLOCK	2
08000H		
07FFFH	16KB BLOCK	1
04000H		
03FFFH	16KB BLOCK	0
00000H		

28F020SUN80-3

Figure 4. Chip Memory Map

BUS OPERATIONS, COMMANDS AND STATUS REGISTER DEFINITIONS

Bus Operations

MODE	\overline{CE}	\overline{OE}	\overline{WE}	A_0	DQ_{0-7}	NOTE
Read	V_{IL}	V_{IL}	V_{IH}	X	D_{OUT}	1
Output Disable	V_{IL}	V_{IH}	V_{IH}	X	High-Z	1
Standby	V_{IH}	X	X	X	High-Z	1
Manufacturer ID	V_{IL}	V_{IL}	V_{IH}	V_{IL}	B0H	2
Device ID	V_{IL}	V_{IL}	V_{IH}	V_{IH}	ID	2
Write	V_{IL}	V_{IH}	V_{IL}	X	D_{IN}	1, 3

NOTES:

1. X can be V_{IH} or V_{IL} for address or control pins, which is either V_{OL} or V_{OH} .
2. A_0 at V_{IL} provide manufacturer ID codes. A_0 at V_{IH} provide device ID codes. Device ID Code = 30H. All other addresses are set to zero.
3. Commands for different Erase operations, Data Write operations of Lock-Block operations can only be successfully completed when $V_{PP} = V_{PPH}$.

LH28F008SA - Compatible Mode Command Bus Definitions

COMMAND	FIRST BUS CYCLE			SECOND BUS CYCLE			NOTE
	OPER.	ADDRESS	DATA	OPER.	ADDRESS	DATA	
Read Array	Write	X	FFH	Read	AA	AD	
Intelligent Identifier	Write	X	90H	Read	IA	ID	1
Read Compatible Status Register	Write	X	70H	Read	X	CSR.D	2
Clear Status Register	Write	X	50H				3
Byte Write	Write	X	40H	Write	WA	WD	
Alternate Byte Write	Write	X	10H	Write	WA	WD	
Block Erase/Confirm	Write	X	20H	Write	BA	D0H	4
Erase Suspend/Resume	Write	X	B0H	Write	X	D0H	4

ADDRESS

AA = Array Address
 BA = Block Address
 IA = Identifier Address
 WA = Write Address
 X = Don't Care

DATA

AD = Array Data
 CSR.D = CSR Data
 ID = Identifier Data
 WD = Write Data

NOTES:

- Following the intelligent identifier command, two Read operations access the manufacturer and device signature codes.
- The CSR is automatically available after device enters Data Write, Erase or Suspend operations.
- Clears CSR.3, CSR.4, and CSR.5. See Status register definitions.
- While device performs Block Erase, if you issue Erase Suspend command (B0H), be sure to confirm ESS (Erase-Suspend-Status) is set to 1 on compatible status register. In the case, ESS bit was not set to 1, also completed the Erase (ESS = 0, WSMS = 1), be sure to issue Resume command (D0H) after completed next Erase command. Beside, when the Erase Suspend command is issued, while the device is not in Erase, be sure to issue Resume command (D0H) after the next erase completed.

LH28F020SUT-N Performance Enhancement Command Bus Definitions

COMMAND	FIRST BUS CYCLE			SECOND BUS CYCLE			THIRD BUS CYCLE			NOTE
	OPER.	ADD.	DATA	OPER.	ADD.	DATA	OPER.	ADD.	DATA	
Protect Set/Confirm	Write	X	57H	Write	0FFH	D0H				1, 2, 6
Protect Reset/Confirm	Write	X	47H	Write	0FFH	D0H				3, 6
Lock Block/Confirm	Write	X	77H	Write	BA	D0H				1, 2, 4
Erase All Unlocked Blocks	Write	X	A7H	Write	X	D0H				1, 2
Two-Byte Write	Write	X	FBH	Write	A0	WD (L, H)	Write	WA	WD (H, L)	1, 2, 5

ADDRESS

BA = Block Address
 WA = Write Address
 X = Don't Care

DATA

AD = Array Data
 WD (L, H) = Write Data (Low, High)
 WD (H, L) = Write Data (High, Low)

NOTES:

- After initial device power-up, or chip reset is completed, the block lock status bits default to the locked state independent of the data in the corresponding lock bits. In order to upload the lock bit status, it requires to write Protect Set/Confirm command.
- To reflect the actual lock-bit status, the Protect Set/Confirm command must be written after Lock Block/Confirm command.
- When Protect Reset/Confirm command is written, all blocks can be written and erased regardless of the state of the lock-bits.
- The Lock Block/Confirm command must be written after Protect Reset/Confirm command was written.
- A_0 is automatically complemented to load second byte of data A_0 value determines which WD is supplied first: $A_0 = 0$ looks at the WDL, $A_0 = 1$ looks at the WDH.
- Second bus cycle address of Protect Set/Confirm and Protect Reset/Confirm command is 0FFH. Specifically $A_9 - A_8 = 0$, $A_7 - A_0 = 1$, others are don't care.

Compatible Status Register

WSMS	ESS	ES	DWS	VPPS	R	R	R
7	6	5	4	3	2	1	0

CSR.7 = WRITE STATE MACHINE STATUS (WSMS)
 1 = Ready
 0 = Busy

CSR.6 = ERASE-SUSPEND STATUS (ESS)
 1 = Erase Suspended
 0 = Erase in Progress/Completed

CSR.5 = ERASE STATUS (ES)
 1 = Error in Block Erasure
 0 = Successful Block Erase

CSR.4 = DATA-WRITE STATUS (DWS)
 1 = Error in Data Write
 0 = Data Write Successful

CSR.3 = V_{PP} STATUS (VPPS)
 1 = V_{PP} Low Detect, Operation Abort
 0 = V_{PP} OK

NOTES:

- WSMS bit must be checked to determine completion of an operation (Erase Suspend, Erase or Data Write) before the appropriate Status bit (ESS, ES or DWS) is checked for success.
- If DWS and ES are set to '1' during an erase attempt, an improper command sequence was entered. Clear the CSR and attempt the operation again.
- The VPPS bit, unlike an A/D converter, does not provide continuous indication of V_{PP} level. The WSM interrogates V_{PP} 's level only after the Data-Write or Erase command sequences have been entered, and informs the system if V_{PP} has not been switched on. VPPS is not guaranteed to report accurate feedback between V_{PPL} and V_{PPH} .
- CSR.2 - CSR.0 = Reserved for future enhancements. These bits are reserved for future use and should be masked out when polling the CSR.

2M FLASH MEMORY SOFTWARE ALGORITHMS

Overview

With the advanced Command User Interface, its Performance Enhancement commands and Status Registers, the software code required to perform a given operation may become more intensive but it will result in much higher write/erase performance compared with current flash memory architectures.

The software flow charts describing how a given operation proceeds are shown here Figure 5 through Figure 7 depict flowcharts using the second generation flash device in the LH28F008SA compatible mode. Figure 8 through Figure 14 depict flowcharts using the second generation flash device's performance enhancement commands mode.

When the device power-up or reset is completed, all blocks come up locked. Therefore, Byte Write, Two Byte Serial Write and Block Erase cannot be performed in each block. However, at that time, Erase All Unlocked Block is performed normally, if used, and reflect actual lock status, also the unlocked block data is erased. When the device power-up or reset is completed, Set Write Protect command must be written to reflect actual block lock status.

Reset Write Protect command must be written before Write Block Lock command. To reflect actual block lock status, Set Write Protect command is succeeded.

The Compatible Status Register (CSR) is used to determine which blocks are locked. In order to see Lock Status of certain block, a Byte Write command (WA = Block Address, WD = FFH) is written to the CUI, after issuing Set Write Protect command. If CSR.7, CSR.5, and CSR.4 (WSMS, ES and DWS) are set to '1's, the block is locked. If CSR.7 is set to '1', the block is not locked.

Reset Write Protect command enables Write/Erase operation to each block.

In the case of Block Erase is performed, the block lock information is also erased. Block Lock command and Set Write Protect command must be written to prohibit Write/Erase operation to each block.

There are unassigned commands. It is not recommended that the customer use any command other than the valid commands specified in "Command Bus Definitions". Sharp reserves the right to redefine these codes for future functions.

2M Flash Memory Algorithm Flowcharts

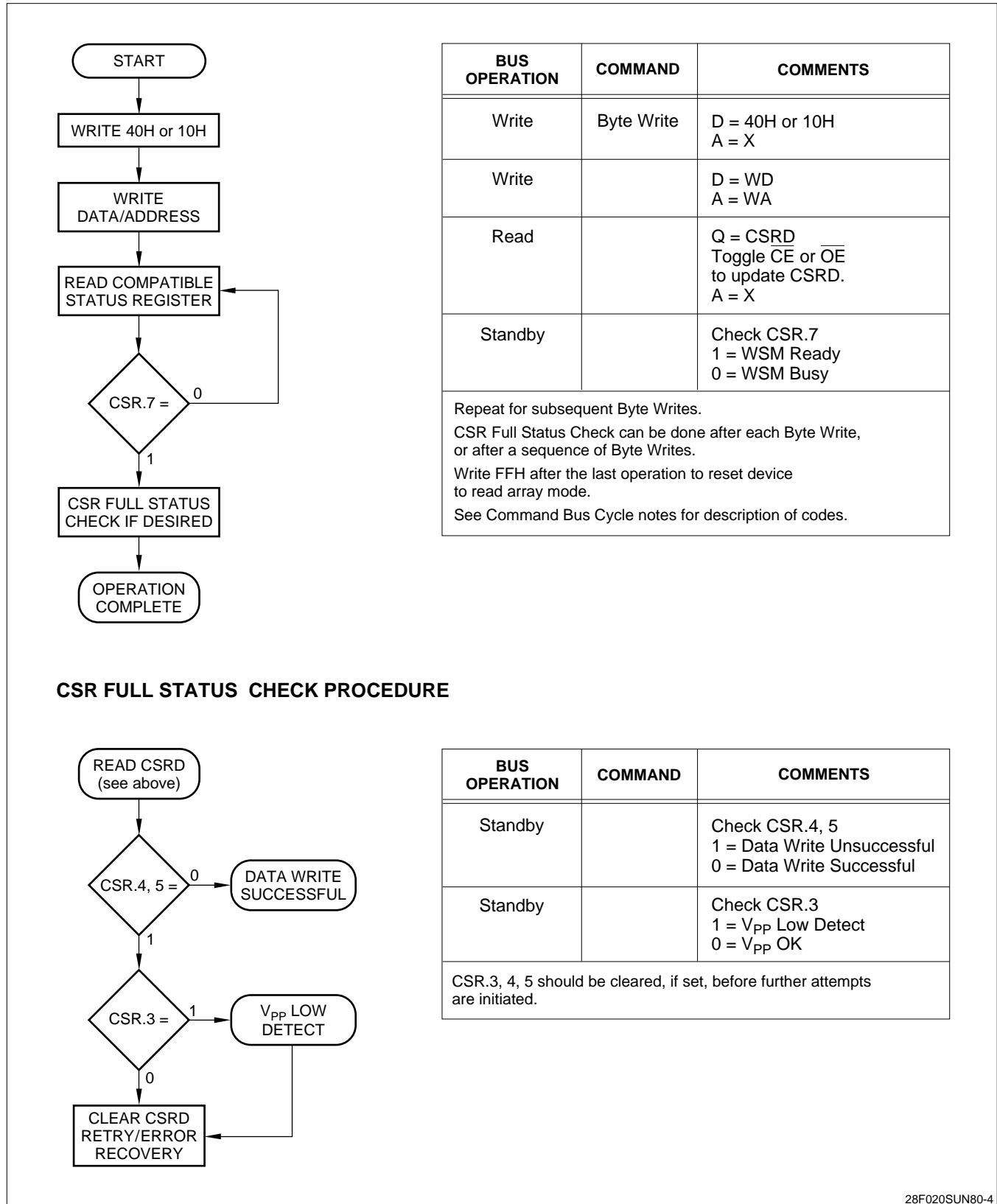

Figure 5. Byte Writes with Compatible Status Register

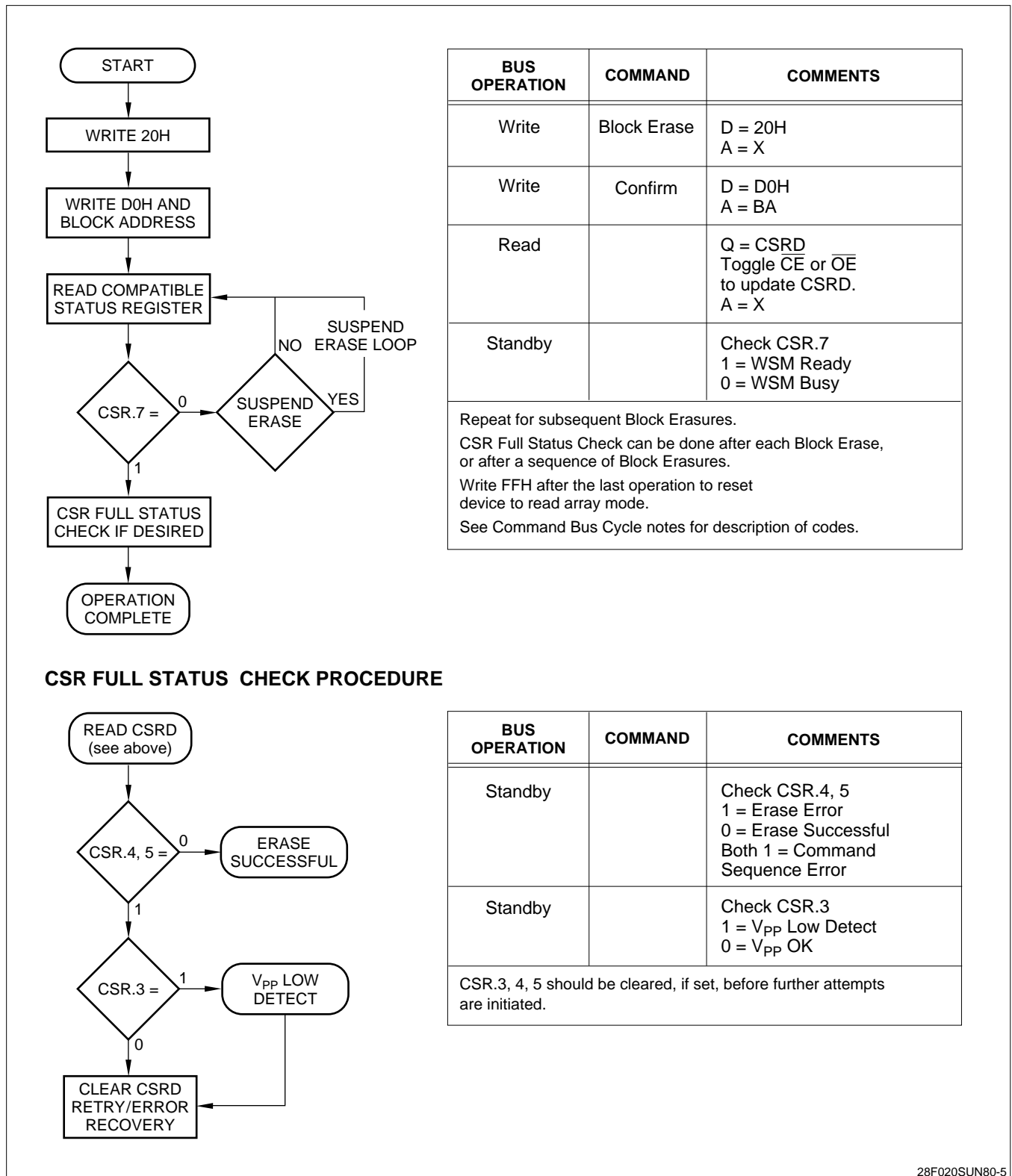

Figure 6. Block Erase with Compatible Status Register

28F020SUN80-5

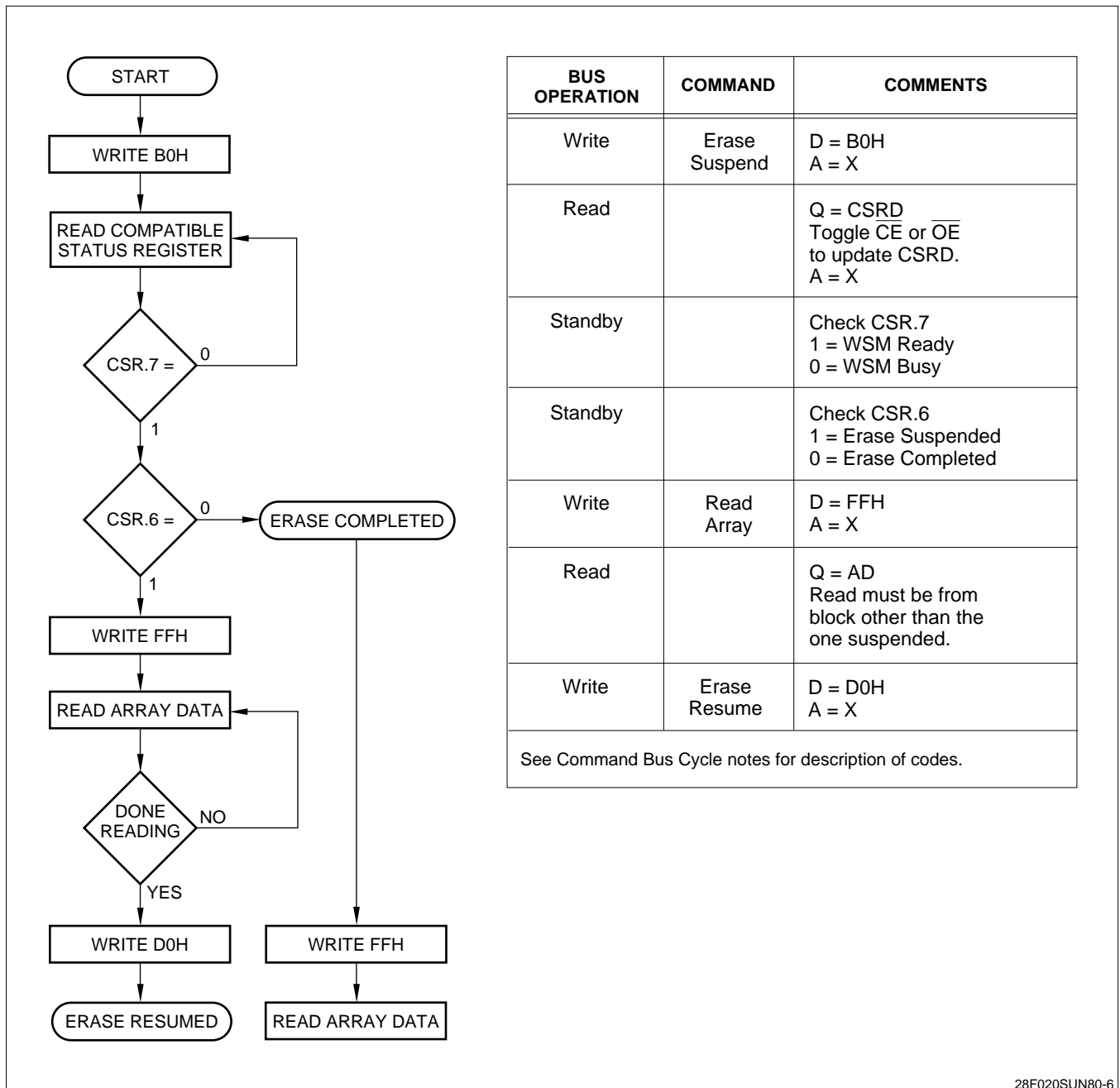

Figure 7. Erase Suspend to Read Array with Compatible Status Register

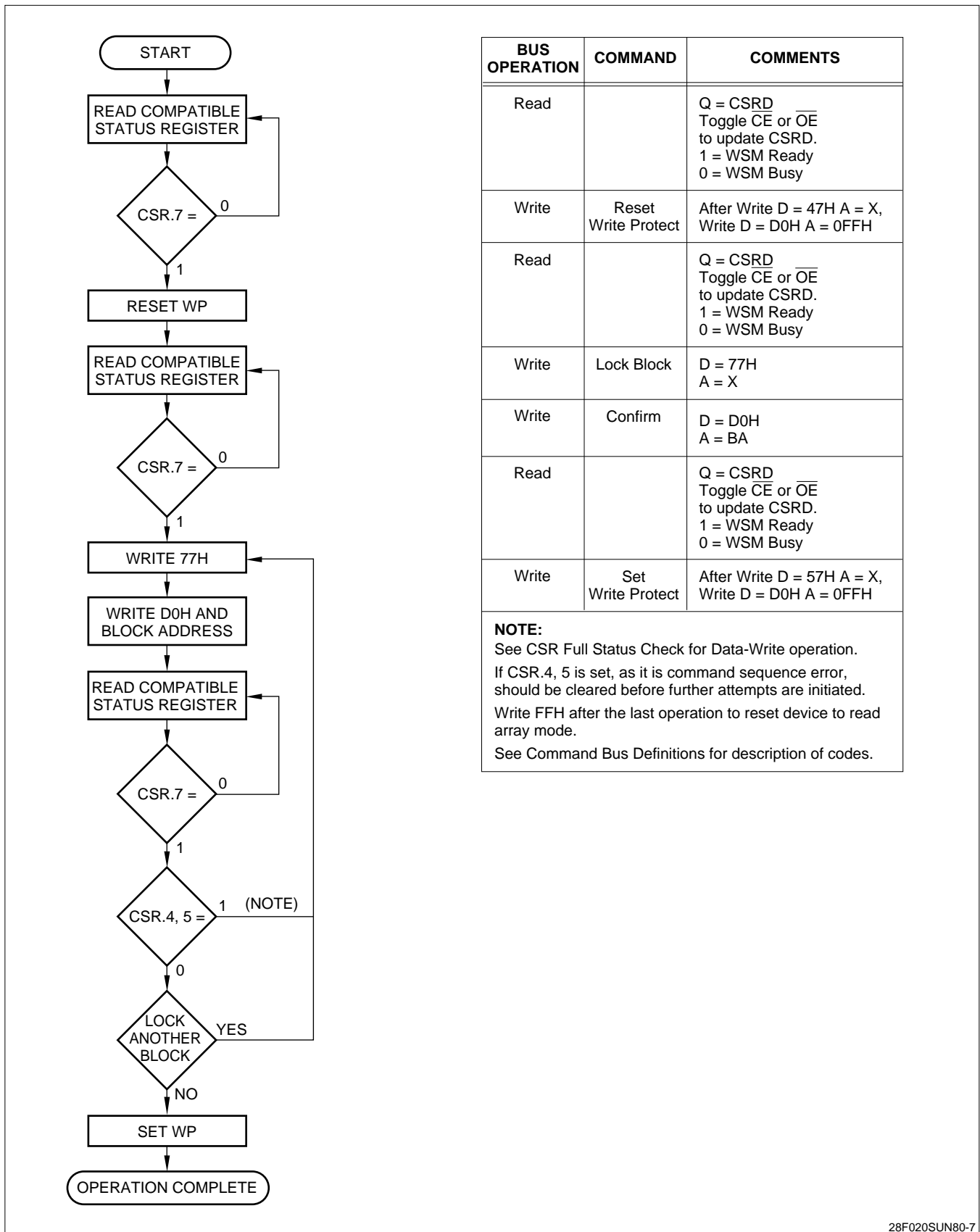

Figure 8. Block Locking

28F020SUN80-7

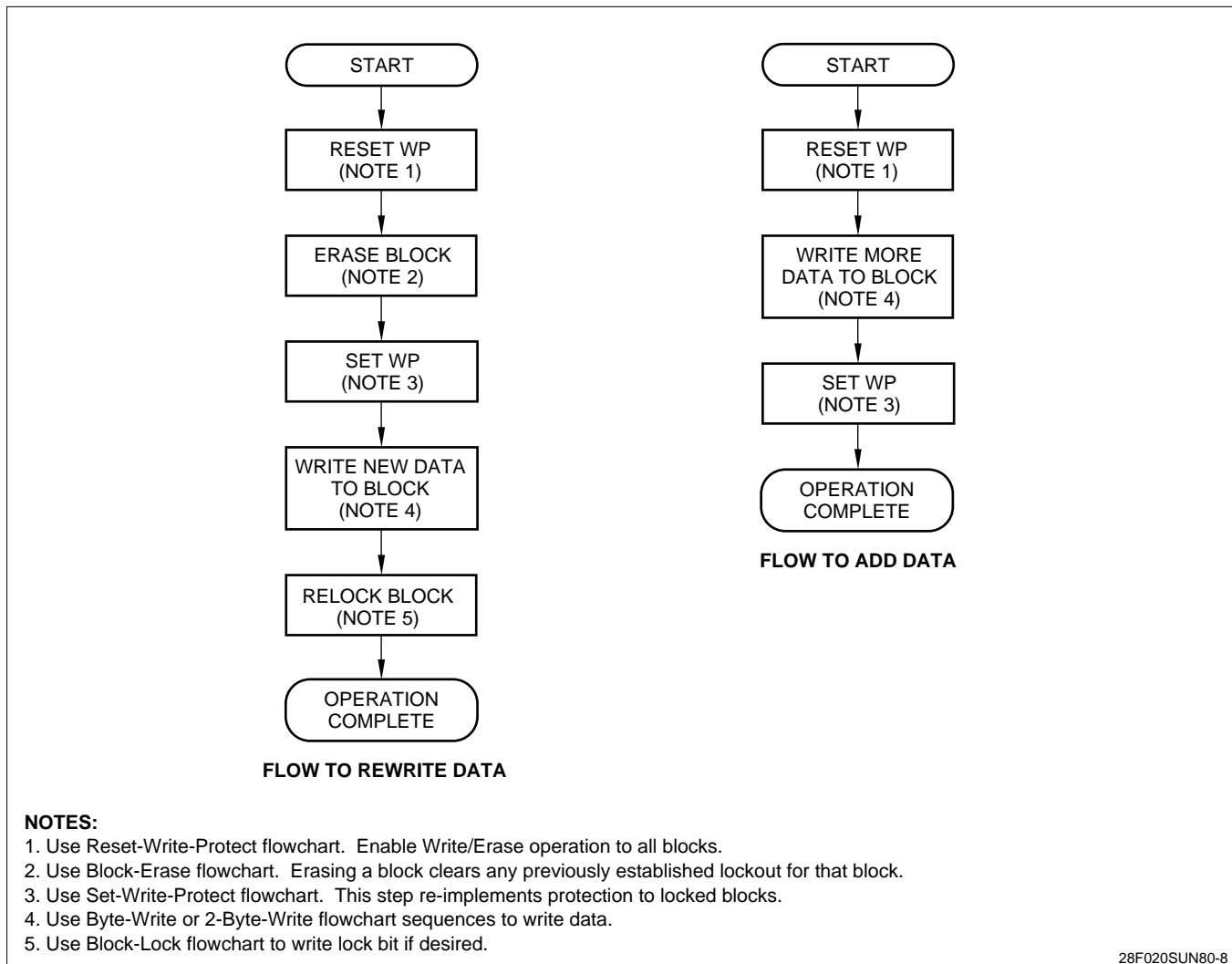

Figure 9. Updating Data in a Locked Block

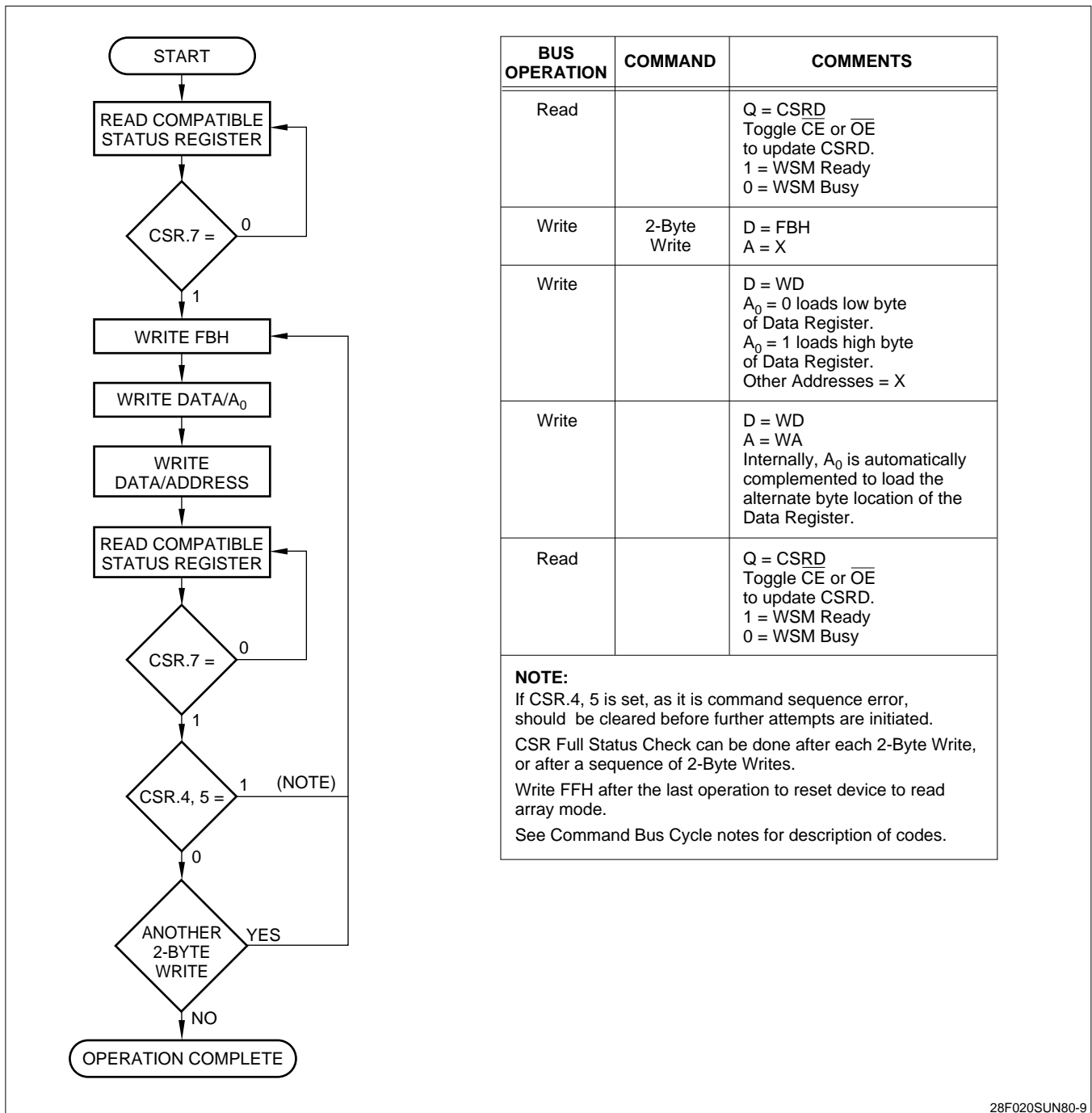
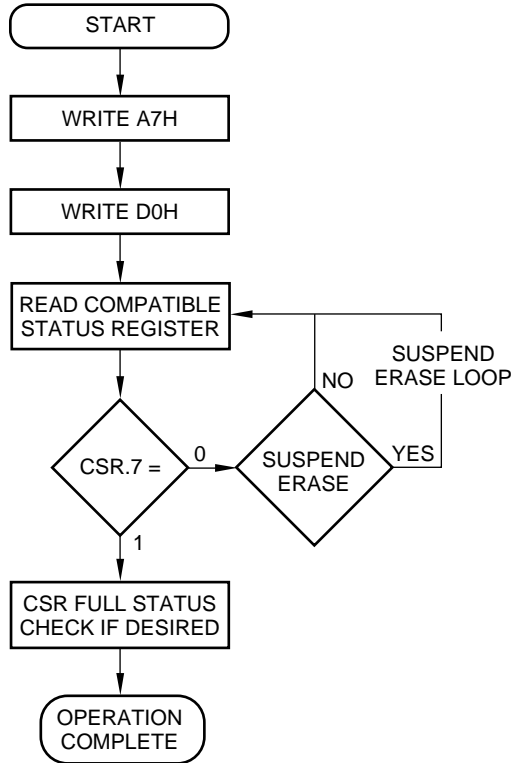

Figure 10. Two-Byte Serial Writes with Compatible Status Registers

28F020SUN80-9



BUS OPERATION	COMMAND	COMMENTS
Write	Erase All Unlocked Blocks	D = A7H A = X
Write	Confirm	D = D0H A = X
Read		Q = CSR.D Toggle CE or OE to update CSR.D A = X
Standby		Check CSR.7 1 = WSM Ready 0 = WSM Busy

CSR Full Status Check can be done after Erase All Unlocked Block, or after a sequence of Erasures.
Write FFH after the last operation to reset device to read array mode.
See Command Bus Cycle notes for description of codes.

CSR FULL STATUS CHECK PROCEDURE

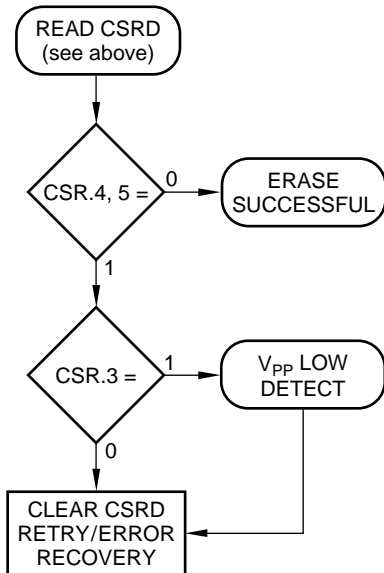

BUS OPERATION	COMMAND	COMMENTS
Standby		Check CSR.4, 5 1 = Erase Error 0 = Erase Successful Both 1 = Command Sequence Error
Standby		Check CSR.3 1 = V _{pp} Low Detect 0 = V _{pp} OK

CSR.3, 4, 5 should be cleared, if set, before further attempts are initiated.

28F020SUN80-10

Figure 11. Erase All Unlocked Blocks with Compatible Status Register

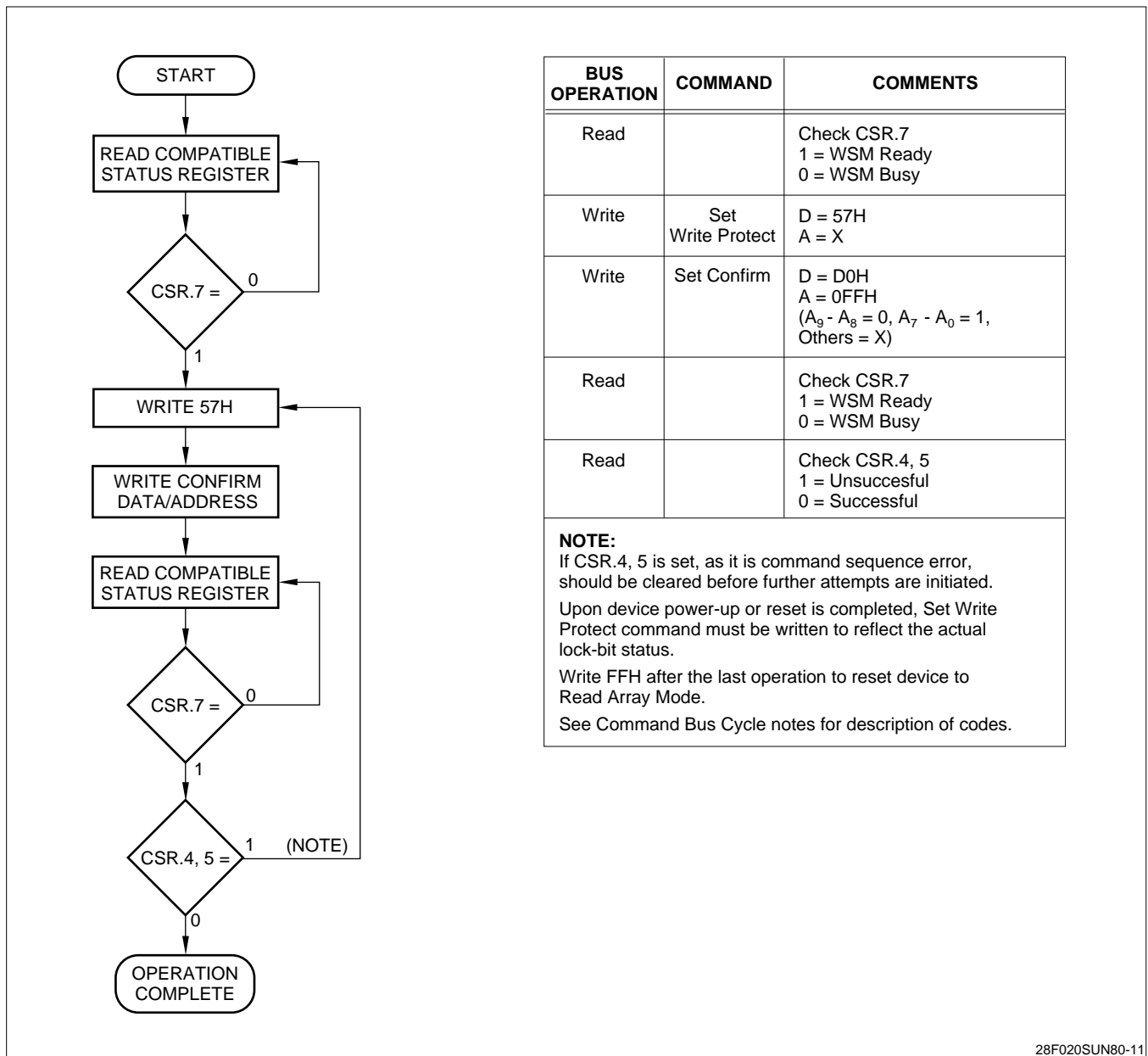
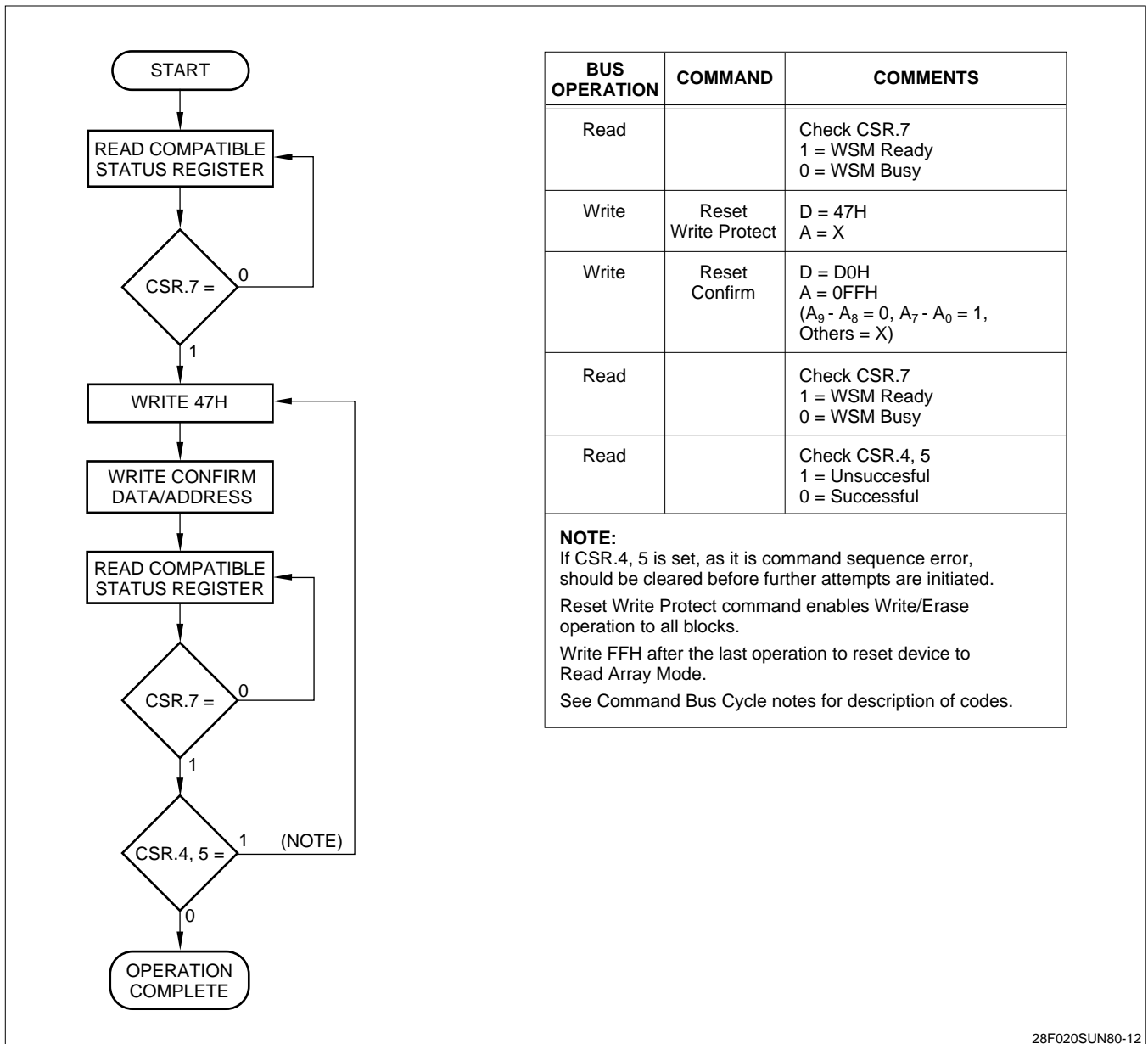

Figure 12. Set Write Protect

28F020SUN80-11



28F020SUN80-12

Figure 13. Reset Write Protect

ELECTRICAL SPECIFICATIONS**Absolute Maximum Ratings***

Temperature Under Bias 0°C to + 80°C

Storage Temperature -65°C to + 125°C

**WARNING: Stressing the device beyond the “Absolute Maximum Ratings” may cause permanent damage. These are stress ratings only. Operation beyond the “Operating Conditions” is not recommended and extended exposure beyond the “Operating Conditions” may affect device reliability.*

SYMBOL	PARAMETER	MIN.	MAX.	UNITS	TEST CONDITIONS	NOTE
T_A	Operating Temperature, Commercial	0	70.0	°C	Ambient Temperature	1
V_{CC}	V_{CC} with Respect to GND	-0.2	7.0	V		2
V_{PP}	V_{PP} Supply Voltage with Respect to GND	-0.2	7.0	V		2
V	Voltage on any Pin (Except V_{CC} , V_{PP}) with Respect to GND	-0.5	7.0	V		2
I	Current into any Non-Supply Pin		±30	mA		
I_{OUT}	Output Short Circuit Current		100.0	mA		3

NOTES:

1. Operating temperature is for commercial product defined by this specification.
2. Minimum DC voltage is -0.5 V on input/output pins. During transitions, this level may undershoot to -2.0 V for periods < 20 ns. Maximum DC voltage on input/output pins is $V_{CC} + 0.5$ V which, during transitions, may overshoot to $V_{CC} + 2.0$ V for periods < 20 ns.
3. Output shorted for no more than one second. No more than one output shorted at a time.

Capacitance

SYMBOL	PARAMETER	TYP.	MAX.	UNITS	TEST CONDITIONS	NOTE
C_{IN}	Capacitance Looking into an Address/Control Pin	7	10	pF	$T_A = 25^\circ\text{C}$, $f = 1.0$ MHz	1
C_{OUT}	Capacitance Looking into an Output Pin	9	12	pF	$T_A = 25^\circ\text{C}$, $f = 1.0$ MHz	1
C_{LOAD}	Load Capacitance Driven by Outputs for Timing Specifications		100	pF	For $V_{CC} = 5.0$ V ±0.5 V	1
	Equivalent Testing Load Circuit $V_{CC} \pm 10\%$		2.5	ns	25 Ω transmission line delay	

NOTE:

1. Sampled, not 100% tested.

Timing Nomenclature

For 3.3 V systems use the standard JEDEC cross point definitions.

Each timing parameter consists of 5 characters. Some common examples are defined below:

- t_{CE} t_{ELQV} time (t) from \overline{CE} (E) going low (L) to the outputs (Q) becoming valid (V)
- t_{OE} t_{GLQV} time (t) from \overline{OE} (G) going low (L) to the outputs (Q) becoming valid (V)
- t_{ACC} t_{AVQV} time (t) from address (A) valid (V) to the outputs (Q) becoming valid (V)
- t_{AS} t_{AVWH} time (t) from address (A) valid (V) to \overline{WE} (W) going high (H)
- t_{DH} t_{WHDx} time (t) from \overline{WE} (W) going high (H) to when the data (D) can become undefined (X)

	PIN CHARACTERS		PIN STATES
A	Address Inputs	H	High
D	Data Inputs	L	Low
Q	Data Outputs	V	Valid
E	\overline{CE} (Chip Enable)	X	Driven, but not necessarily valid
G	\overline{OE} (Output Enable)	Z	High Impedance
W	\overline{WE} (Write Enable)		
V	Any Voltage Level		
3 V	V_{CC} at 3.0 V MIN.		

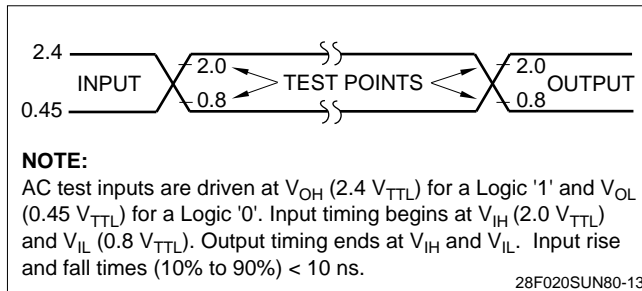

Figure 14. Transient Input/Output Reference Waveform ($V_{CC} = 5.0 V$)

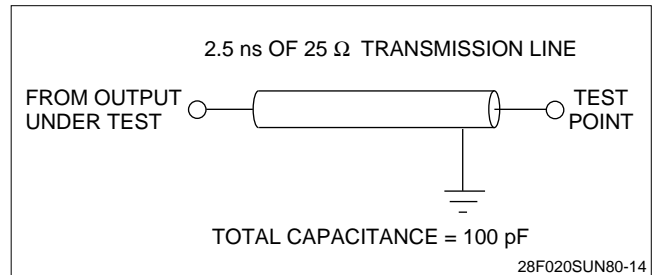

Figure 15. Transient Equivalent Testing Load Circuit ($V_{CC} = 5.0 V$)

DC Characteristics

$$V_{CC} = 5.0 \text{ V} \pm 0.5 \text{ V}, T_A = 0^\circ\text{C to } +70^\circ\text{C}$$

SYMBOL	PARAMETER	TYP.	MIN.	MAX.	UNITS	TEST CONDITIONS	NOTE
I_{IL}	Input Load Current			±1	μA	$V_{CC} = V_{CC \text{ MAX.}}, V_{IN} = V_{CC} \text{ or GND}$	1
I_{LO}	Output Leakage Current			±10	μA	$V_{CC} = V_{CC \text{ MAX.}}, V_{IN} = V_{CC} \text{ or GND}$	1
I_{CCS}	V_{CC} Standby Current	5		10	μA	$V_{CC} = V_{CC \text{ MAX.}},$ $\overline{CE} = V_{CC} \pm 0.2\text{V}$	1,4
		1		4	mA	$V_{CC} = V_{CC \text{ MAX.}},$ $\overline{CE} = V_{IH}$	
I_{CCR}^1	V_{CC} Read Current			60	mA	$V_{CC} = V_{CC \text{ MAX.}},$ CMOS: $\overline{CE} = \text{GND} \pm 0.2 \text{ V}$ Inputs = $\text{GND} \pm 0.2 \text{ V}$ or $V_{CC} \pm 0.2 \text{ V}$ TTL: $\overline{CE} = V_{IL}$ Inputs = V_{IL} or V_{IH} $f = 10 \text{ MHz}, I_{OUT} = 0 \text{ mA}$	1, 3, 4
I_{CCR}^2	V_{CC} Read Current	13		30	mA	$V_{CC} = V_{CC \text{ MAX.}},$ CMOS: $\overline{CE} = \text{GND} \pm 0.2 \text{ V}$ Inputs = $\text{GND} \pm 0.2 \text{ V}$ or $V_{CC} \pm 0.2 \text{ V}$ TTL: $\overline{CE} = V_{IL}$ Inputs = V_{IL} or V_{IH} $f = 5 \text{ MHz}, I_{OUT} = 0 \text{ mA}$	1, 3, 4
I_{CCW}	V_{CC} Write Current	18		35	mA	Byte/Two-Byte Serial Write in Progress	1
I_{CCE}	V_{CC} Block Erase Current	18		25	mA	Block Erase in Progress	1
I_{CCES}	V_{CC} Erase Suspend Current	5		10	mA	$\overline{CE} = V_{IH}$ Block Erase Suspended	1, 2
I_{PPS}	V_{PP} Standby Current			±10	μA	$V_{PP} \leq V_{CC}$	1

DC Characteristics (Continued)

$$V_{CC} = 5.0 \text{ V} \pm 0.5 \text{ V}, T_A = 0^\circ\text{C to } +70^\circ\text{C}$$

SYMBOL	PARAMETER	TYP.	MIN.	MAX.	UNITS	TEST CONDITIONS	NOTE
I_{PPR}	V_{PP} Read Current	65		200	μA	$V_{PP} > V_{CC}$	1
I_{PPW}	V_{PP} Write Current	15		35	mA	$V_{PP} = V_{PPH}$, Byte/Two-Byte Serial Write in Progress	1
I_{PPE}	V_{PP} Erase Current	20		40	mA	$V_{PP} = V_{PPH}$, Block Erase in Progress	1
I_{PPES}	V_{PP} Erase Suspend Current	65		200	μA	$V_{PP} = V_{PPH}$, Block Erase Suspended	1
V_{IL}	Input Low Voltage		-0.5	0.8	V		
V_{IH}	Input High Voltage		2.0	$V_{CC} + 0.5$	V		
V_{OL}	Output Low Voltage			0.45	V	$V_{CC} = V_{CC} \text{ MIN.}$ and $I_{OL} = 5.8 \text{ mA}$	
V_{OH}^1	Output High Voltage		0.85 V_{CC}		V	$I_{OH} = -2.5 \text{ mA}$ $V_{CC} = V_{CC} \text{ MIN.}$	
V_{OH}^2			V_{CC} - 0.4		V	$I_{OH} = -100 \mu\text{A}$ $V_{CC} = V_{CC} \text{ MIN.}$	
V_{PPL}	V_{PP} during Normal Operations		0.0	5.5	V		
V_{PPH}	V_{PP} during Write/Erase Operations	5.0	4.5	5.5	V		
V_{LKO}	V_{CC} Erase/Write Lock Voltage		1.4		V		

NOTES:

- All currents are in RMS unless otherwise noted. Typical values at $V_{CC} = 5.0 \text{ V}$, $V_{PP} = 5.0 \text{ V}$, $T = 25^\circ\text{C}$.
- I_{CCES} is specified with the device de-selected. If the device is read while in erase suspend mode, current draw is the sum of I_{CCES} and I_{CCR} .
- Automatic Power Saving (APS) reduces I_{CCR} to less than 2 mA in Static operation.
- CMOS inputs are either $V_{CC} \pm 0.2 \text{ V}$ or $\text{GND} \pm 0.2 \text{ V}$. TTL Inputs are either V_{IL} or V_{IH} .

AC Characteristics - Read Only Operations¹

$$V_{CC} = 5.0\text{ V} \pm 0.5\text{ V}, T_A = 0^\circ\text{C to } +70^\circ\text{C}$$

SYMBOL	PARAMETER	MIN.	MAX.	UNITS	NOTE
t_{AVAV}	Read Cycle Time	80		ns	
t_{AVGL}	Address Setup to \overline{OE} Going Low	0		ns	3
t_{AVQV}	Address to Output Delay		80	ns	
t_{ELQV}	\overline{CE} to Output Delay		80	ns	2
t_{GLQV}	\overline{OE} to Output Delay		35	ns	2
t_{ELQX}	\overline{CE} to Output in Low Z	0		ns	3
t_{EHQZ}	\overline{CE} to Output in High Z		30	ns	3
t_{GLQX}	\overline{OE} to Output in Low Z	0		ns	3
t_{GHQZ}	\overline{OE} to Output in High Z		30	ns	3
t_{OH}	Output Hold from Address, \overline{CE} or \overline{OE} change, whichever occurs first	0		ns	3

NOTES:

1. See AC Input/Output Reference Waveforms for timing measurements, Figure 4.
2. \overline{OE} may be delayed up to $t_{ELQV} - t_{GLQV}$ after the falling edge of \overline{CE} without impact on t_{ELQV} .
3. Sampled, not 100% tested.

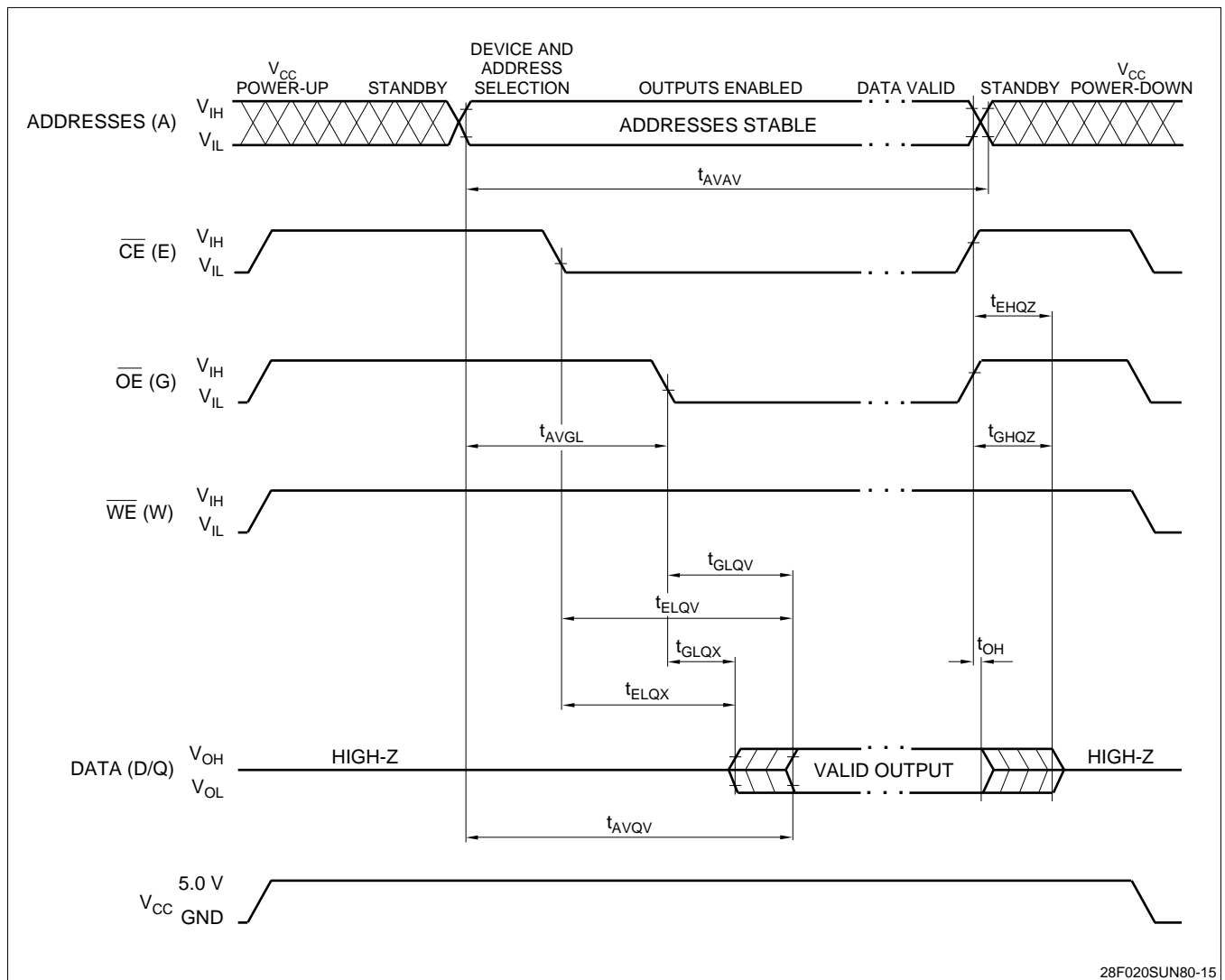

Figure 16. Read Timing Waveforms

28F020SUN80-15

POWER-UP AND RESET TIMINGS

SYMBOL	PARAMETER	MIN.	MAX.	UNITS	NOTE
t_{WLPL}	\overline{WE} Low to V_{CC} at 4.5 V MIN.	5		μs	1
t_{AVQV}	Address Valid to Data Valid for V_{CC} 5.0 V \pm 10%		80	ns	2
t_{PHQV}	\overline{WE} High to Data Valid for V_{CC} 5.0 V \pm 10%		500	ns	2
t_{ELRS}	\overline{CE} Setup to \overline{WE} Going Low	100		ns	
t_{GLRS}	\overline{OE} Setup to \overline{WE} Going Low	100		ns	
t_{EHRS}	\overline{CE} Hold from \overline{WE} Going High	100		ns	
t_{GHRS}	\overline{OE} Hold from \overline{WE} Going High	100		ns	

NOTES:

\overline{CE} and \overline{OE} are switched low after Power-Up.

1. Chip reset is enabled when the low state of all \overline{CE} , \overline{OE} , and \overline{WE} exceeds 5 μs . This state should be used only for chip reset.
2. These values are shown for 3.5 V V_{CC} operation. Refer to the AC Characteristics Read Only Operations also.

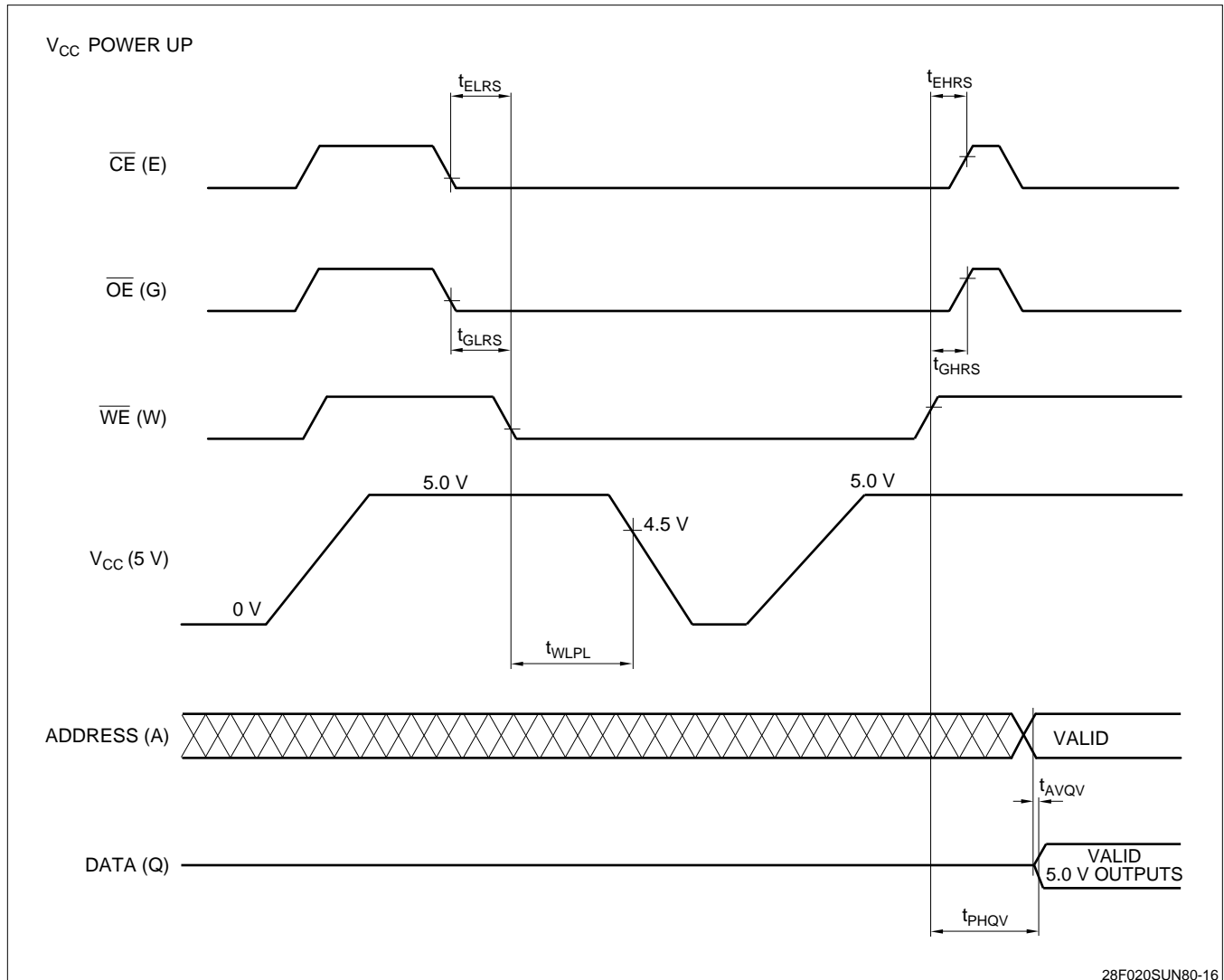

Figure 17. V_{CC} Power-Up and Reset Waveforms

AC Characteristics for \overline{WE} - Controlled Command Write Operations¹

$$V_{CC} = 5.0 \pm 0.5 \text{ V}, T_A = 0^\circ \text{ to } 70^\circ \text{C}$$

SYMBOL	PARAMETER	TYP.	MIN.	MAX.	UNITS	NOTE
t_{AVAV}	Write Cycle Time		80		ns	
t_{VPWH}	V_{PP} Setup to \overline{WE} Going High		100		ns	3
t_{ELWL}	\overline{CE} Setup to \overline{WE} Going Low		0		ns	
t_{AVWH}	Address Setup to \overline{WE} Going High		55		ns	2, 6
t_{DVWH}	Data Setup to \overline{WE} Going High		55		ns	2, 6
t_{WLWH}	\overline{WE} Pulse Width		55		ns	
t_{WHDX}	Data Hold from \overline{WE} High		0		ns	2
t_{WHAX}	Address Hold from \overline{WE} High		10		ns	2
t_{WHEH}	\overline{CE} Hold from \overline{WE} High		10		ns	
t_{WHWL}	\overline{WE} Pulse Width High		30		ns	
t_{GHWL}	Read Recovery before Write		0		ns	
t_{WHGL}	Write Recovery before Read		65		ns	
t_{QVVL}	V_{PP} Hold from Valid Status Register Data		0		μs	
t_{WHQV}^1	Duration of Byte Write Operation	13	4.5		μs	4, 5
t_{WHQV}^2	Duration of Block Erase Operations		0.3		s	4

NOTES:

1. Read timing during write and erase are the same as for normal read.
2. Refer to command definition tables for valid address and data values.
3. Sampled, but not 100% tested.
4. Write/Erase durations are measured to valid Status Register (CSR) Data.
5. Byte write operations are typically performed with 1 Programming Pulse.
6. Address and Data are latched on the rising edge of \overline{WE} for all Command Write operations.

AC Characteristics for \overline{CE} - Controlled Command Write Operations¹

$$V_{CC} = 5.0 \text{ V} \pm 0.5 \text{ V}, T_A = 0^\circ\text{C to } +70^\circ\text{C}$$

SYMBOL	PARAMETER	TYP.	MIN.	MAX.	UNITS	NOTE
t_{AVAV}	Write Cycle Time		80		ns	
t_{VPEH}	V_{PP} Setup to \overline{CE} Going High		100		ns	3
t_{WLEL}	\overline{WE} Setup to \overline{CE} Going Low		0		ns	
t_{AVEH}	Address Setup to \overline{CE} Going High		55		ns	2, 6
t_{DVEH}	Data Setup to \overline{CE} Going High		55		ns	2, 6
t_{ELEH}	\overline{CE} Pulse Width		55		ns	
t_{EHDX}	Data Hold from \overline{CE} High		0		ns	2
t_{EHAX}	Address Hold from \overline{CE} High		10		ns	2
t_{EHWH}	\overline{WE} Hold from \overline{CE} High		10		ns	
t_{EHEL}	\overline{CE} Pulse Width High		30		ns	
t_{GHEL}	Read Recovery before Write		0		ns	
t_{EHGL}	Write Recovery before Read		65		ns	
t_{QVVL}	V_{PP} Hold from Valid Status Register Data		0		μs	
t_{EHQV}^1	Duration of Byte Write Operation	13	4.5		μs	4, 5
t_{EHQV}^2	Duration of Block Erase Operations		0.3		s	4

NOTES:

1. Read timing during write and erase are the same as for normal read.
2. Refer to command definition tables for valid address and data values.
3. Sampled, but not 100% tested.
4. Write/Erase durations are measured to valid Status Register (CSR) Data.
5. Byte Write operations are typically performed with 1 Programming Pulse.
6. Address and Data are latched on the rising edge of \overline{CE} for all Command Write Operations.

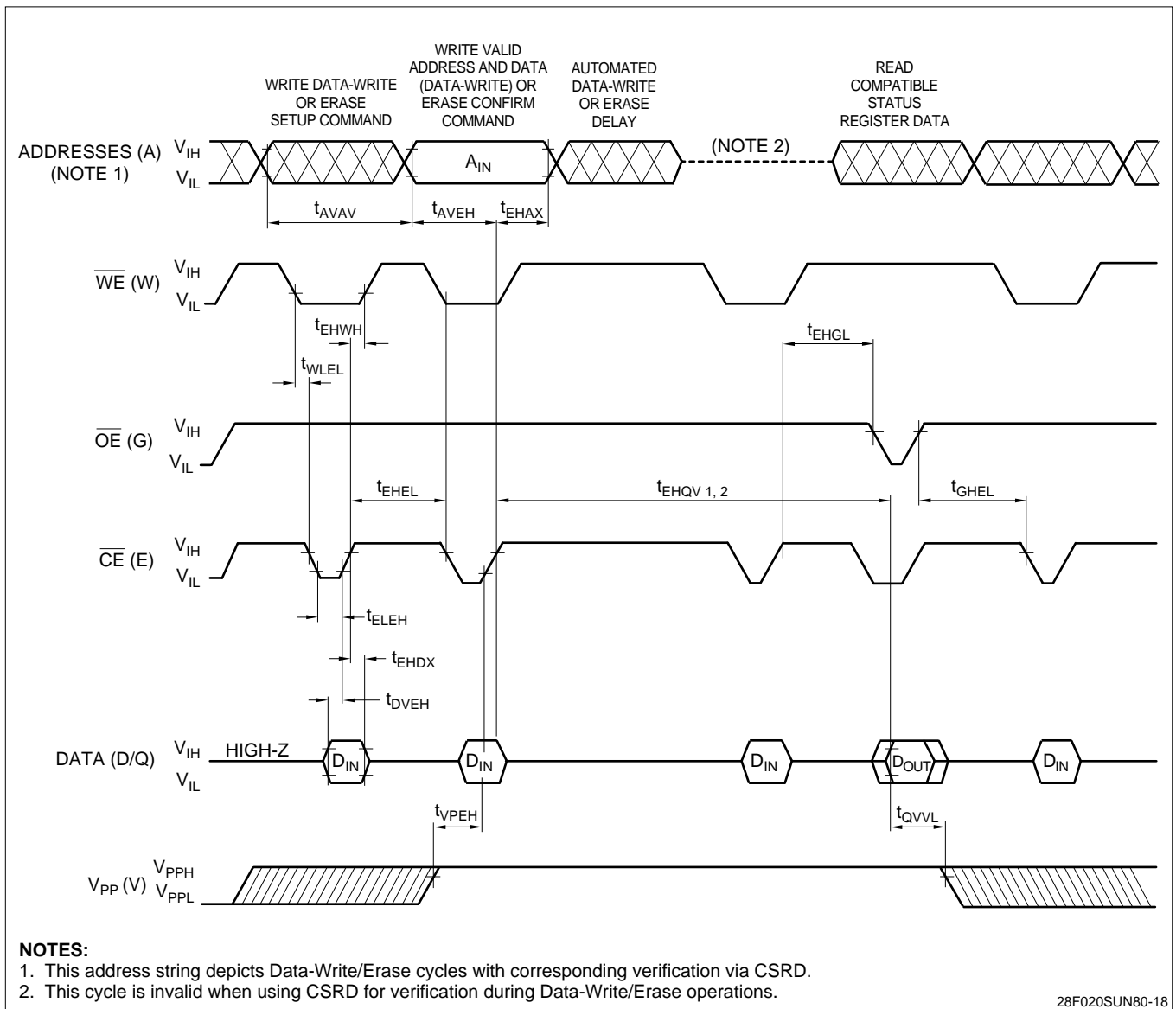

Figure 19. Alternate AC Waveforms for Command Write Operations

Erase and Byte Write Performance

$$V_{CC} = 5.0\text{ V} \pm 0.5\text{ V}, T_A = 0^\circ\text{C to } +70^\circ\text{C}$$

SYMBOL	PARAMETER	TYP. ¹	MIN.	MAX.	UNITS	TEST CONDITIONS	NOTE
t_{WHRH}^1	Byte Write Time	13			μs		2
t_{WHRH}^2	Two-Byte Serial Write Time	20			μs		2
t_{WHRH}^3	16KB Block Write Time	0.22		1.0	s	Byte Write Mode	2
t_{WHRH}^4	16KB Block Write Time	0.17		1.0	s	Two-Byte Serial Write Mode	2
	Block Erase Time (16K)	0.6		10.0	s		2
	Full Chip Erase Time	4.4 - 7.2			s		2, 3

NOTES:

1. 25°C, $V_{PP} = 5.0\text{ V}$
2. Excludes System-Level Overhead.
3. Depends on the number of protected blocks.

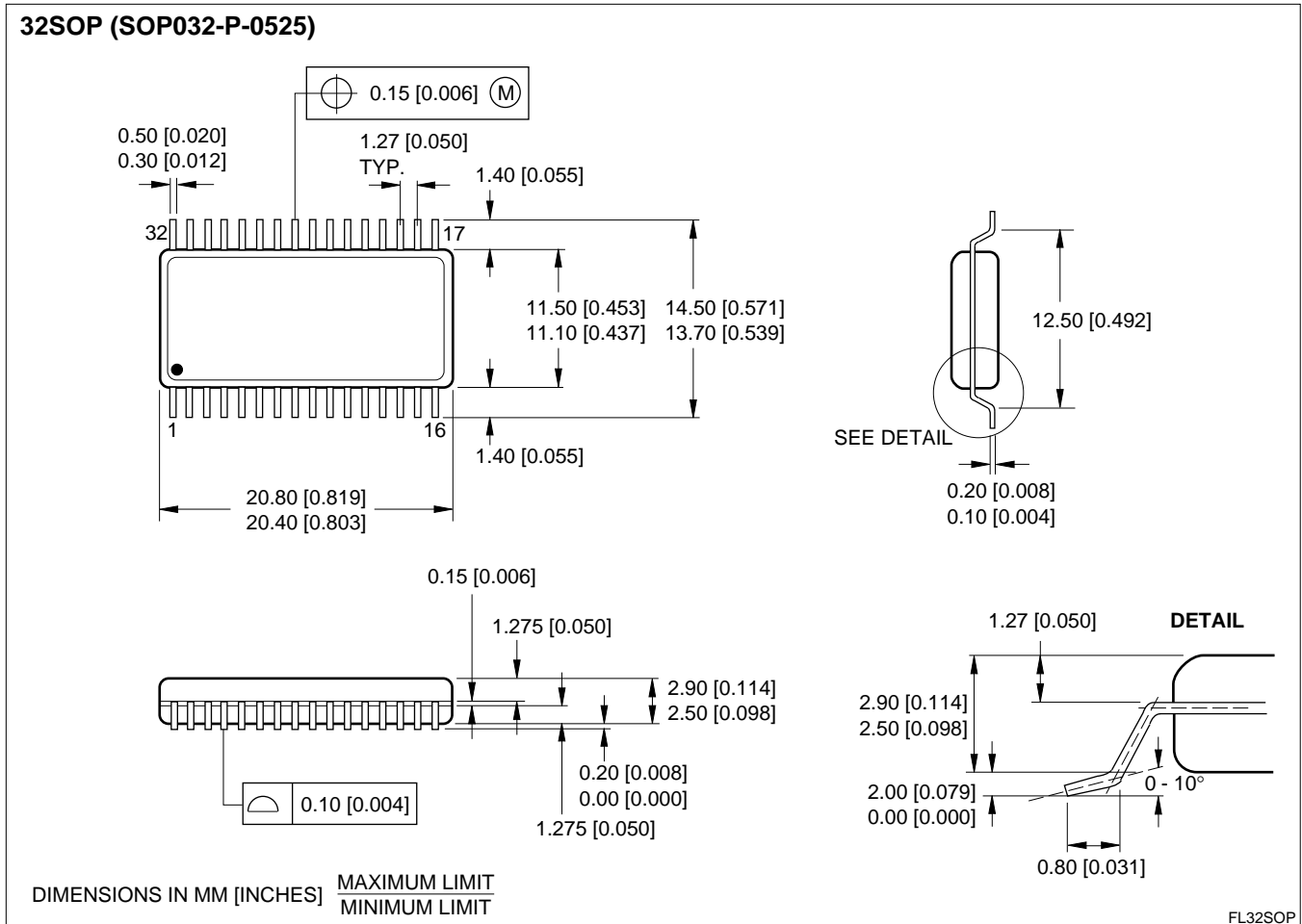

Figure 20. 32-Pin SOP

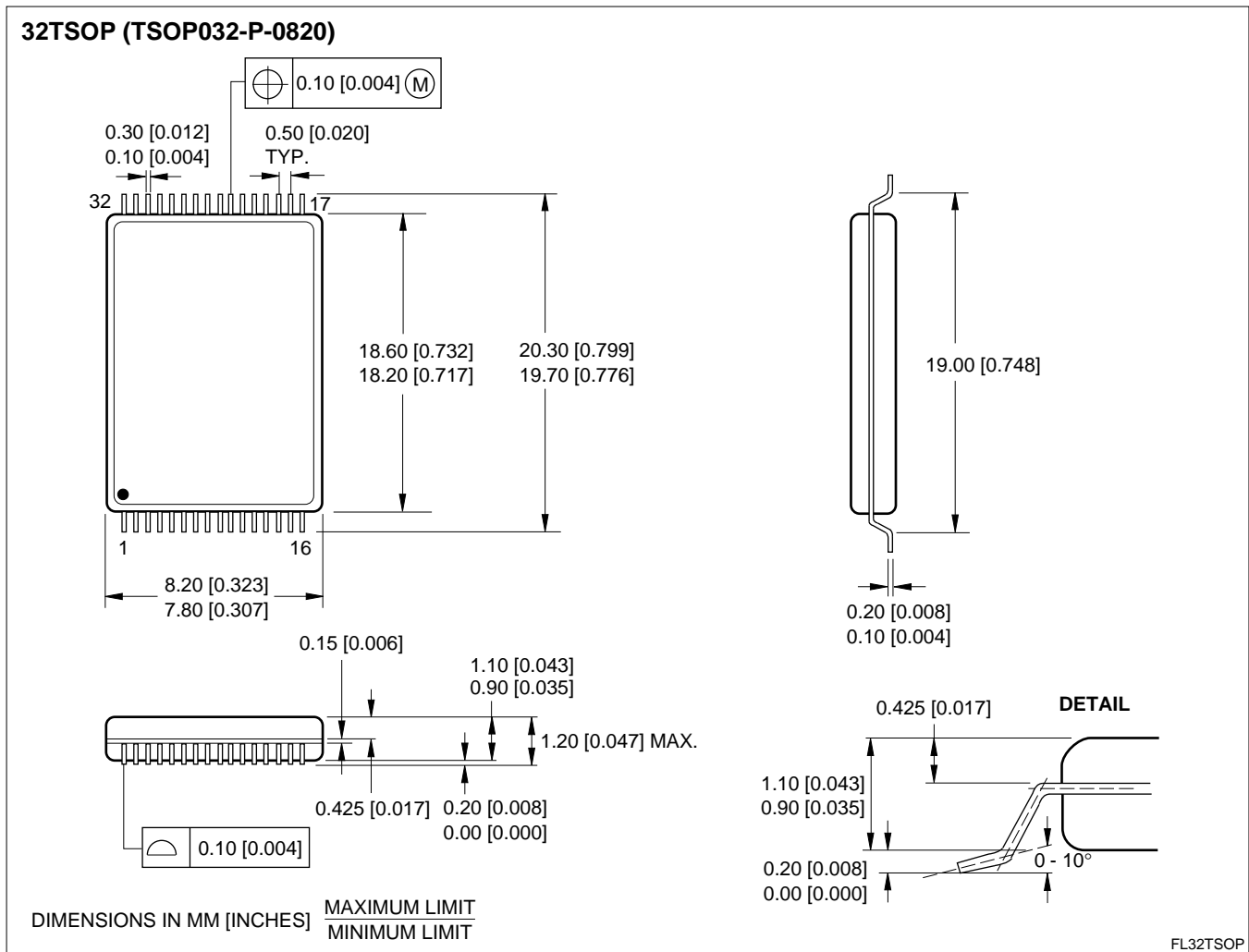
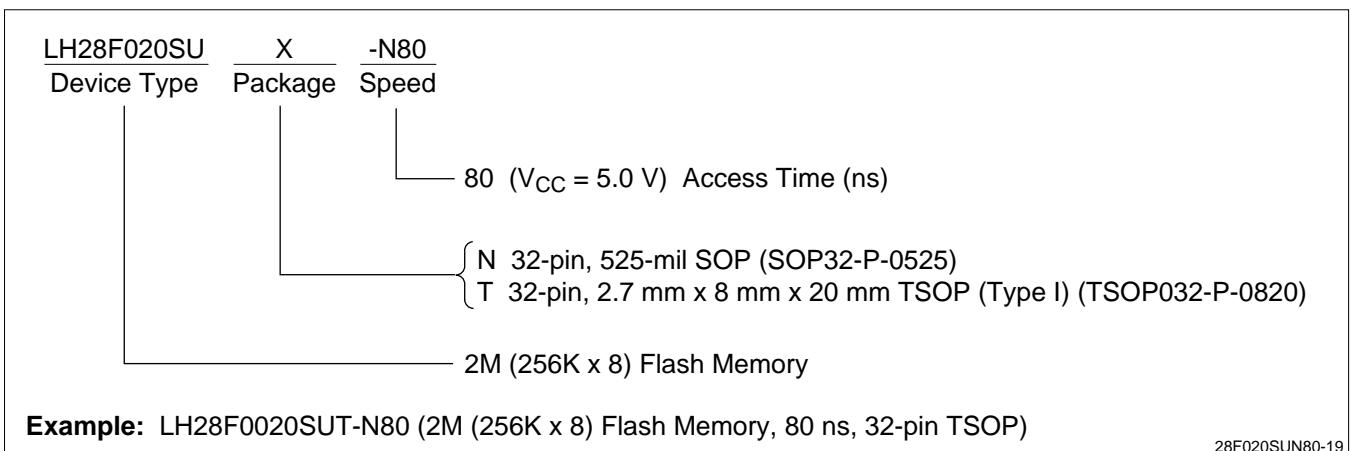

Figure 21. 32-Pin TSOP

ORDERING INFORMATION



28F020SUN80-19

LIFE SUPPORT POLICY

SHARP components should not be used in medical devices with life support functions or in safety equipment (or similar applications where component failure would result in loss of life or physical harm) without the written approval of an officer of the SHARP Corporation.

WARRANTY

SHARP warrants to Customer that the Products will be free from defects in material and workmanship under normal use and service for a period of one year from the date of invoice. Customer's exclusive remedy for breach of this warranty is that SHARP will either (i) repair or replace, at its option, any Product which fails during the warranty period because of such defect (if Customer promptly reported the failure to SHARP in writing) or, (ii) if SHARP is unable to repair or replace, SHARP will refund the purchase price of the Product upon its return to SHARP. This warranty does not apply to any Product which has been subjected to misuse, abnormal service or handling, or which has been altered or modified in design or construction, or which has been serviced or repaired by anyone other than SHARP. The warranties set forth herein are in lieu of, and exclusive of, all other warranties, express or implied. ALL EXPRESS AND IMPLIED WARRANTIES OF MERCHANTABILITY, FITNESS FOR USE AND FITNESS FOR A PARTICULAR PURPOSE ARE SPECIFICALLY EXCLUDED.

SHARP reserves the right to make changes in specifications at any time and without notice. SHARP does not assume any responsibility for the use of any circuitry described; no circuit patent licenses are implied.

SHARP[®]**NORTH AMERICA**

SHARP Electronics Corporation
Microelectronics Group
5700 NW Pacific Rim Blvd., M/S 20
Camas, WA 98607, U.S.A.
Phone: (360) 834-2500
Telex: 49608472 (SHARPCAM)
Facsimile: (360) 834-8903
<http://www.sharpmeg.com>

EUROPE

SHARP Electronics (Europe) GmbH
Microelectronics Division
SonninstraÙe 3
20097 Hamburg, Germany
Phone: (49) 40 2376-2286
Telex: 2161867 (HEEG D)
Facsimile: (49) 40 2376-2232

ASIA

SHARP Corporation
Integrated Circuits Group
2613-1 Ichinomoto-Cho
Tenri-City, Nara, 632, Japan
Phone: (07436) 5-1321
Telex: LABOMETA-B J63428
Facsimile: (07436) 5-1532